



Cold Plunge Chiller
FDC-1A
Operation Manual

Congratulations on your purchase of your Cold Plunge Chiller. We are confident that you will enjoy the many benefits for years to come.

Carefully read this manual before using your chiller for the first time. We recommend keeping this manual for review and future reference.

CONTENTS

1 GENERAL INFO	3
1.1 Foreword	3
1.2 General Safety Instructions.....	3
1.2.1 Statement	3
1.2.2 General.....	4
1.2.3 For Anti-Explosion	4
1.2.4 Electrical Safety.....	4
1.2.5 Others.....	6
2 OVERVIEW OF THE UNIT	7
2.1 Parameters	7
2.2 Appearance.....	8
2.3 Dimensions of the Unit.....	8
2.4 Components.....	9
2.5 Included Accessories.....	10
3 INSTALLATION AND CONNECTION	10
3.1 Transportation	10
3.2 Installation Instruction	11
3.2.1 Location and Space	11
3.2.2 Installation Layout	13
3.2.3 Leveling	13
3.2.4 Electrical Installation.....	13
3.3 Assembly.....	14
3.3.1 Connecting Water Lines.....	14
3.3.2 Inspect Water Filters.....	14
4 TRIAL AFTER INSTALLATION	15
4.1 Inspection Before Trial Running.....	15
4.2 Trial Running.....	15
5 CONTROLLER OPERATION	16
5.1 Control Panel Diagram.....	16
5.1.1 Power On Interface	16
5.1.2 Main Interface.....	17
5.1.3 Symbols and Indication Instructions.....	17
5.2 Key Operating Instruction	18
5.3 Wi-Fi Settings.....	22
5.3.1 Wi-Fi Module configuration steps:.....	22
5.3.2 Software Installation.....	23
5.3.3 Software Startup.....	23
5.3.4 Software Registration and Configuration	24
5.3.5 Software Function Operation	28
6 TROUBLESHOOTING.....	29
8 MAINTENANCE.....	30
8.1 Cleaning.....	30
8.2 Annual Maintenance	30
9 WARRANTY.....	31

1 GENERAL INFO

1.1 Foreword

Read and Store Manual

This user manual accompanies an FDC-1A chiller (here after referred to as the “product”). Please read this manual in detail before using the product.

Proper Use

- a. The product is designed solely for a connection with a cold plunge.
- b. Use the product only as described in this user manual. Any other usage is regarded as improper and may lead to damage to property or personal injury. Finnmark Designs nor any affiliates shall be held liable for damages or injuries caused by improper, incorrect or negligent use.

Explanation of Symbols

The symbols in the manual are divided into three categories: Warning, Notice, and Info. The warning symbol indicates a potentially medium-risk hazard that should be avoided with caution as death or serious personal injury may result. Please be sure to carefully read the points where this symbol appears, which can help you effectively avoid these risks.



The notice symbol indicates a potentially low-risk hazard that should be avoided with caution or could result in death or serious personal injury. Please be sure to carefully read the points where this symbol appears, which can help you effectively avoid these risks.



The info symbol indicates additional information and some attention to detail.



1.2 General Safety Instructions

1.2.1 Statement

The following safety factors need to be considered:

- ① Please read the following warnings before installation.
- ② Be sure to check the details that need attention, including safety factors.
- ③ After reading the installation instructions, be sure to save them for future reference.

1.2.2 General Safety Instructions

- Only connect the product when the line voltage of the socket matches the data on the nameplate. The FDC-1A should be used with the supplied GFCI outlet.
- Do not use the product if it is damaged or if the power cord or plug is damaged. If the power cord is damaged, it should be replaced by the manufacturer to avoid any potential risks.
- Do not open the housing. It should be repaired by a certified and approved representative of the manufacturer. Otherwise, liability and warranty claims will be waived. Use only parts that comply with the original equipment data for repairs.
- Do not use an external timer or a separate remote-control system.
- The product is intended to be free-standing and should not be placed in a recessed area.
- Do not place heavy objects or magnetic items on top of the product.
- Do not place the chiller directly up against a wall.
- Stop using the product if its parts exhibit cracks or breaks or are deformed. Only replace damaged parts with corresponding OEM replacement parts.
- Never cover the intakes or exhaust openings with clothes, towels, or other objects.
- Do not carry or store the chiller upside down.
- Never move the product with the water hoses plugged into the bath.
- Never pull on the water hose to move the product.
- Warning! Although the cool and heat temperature limit settings can be adjusted below 32°F and above 105°F, it is strongly recommended to NOT adjust these.

1.2.3 Anti-Explosion



WARNING

Flammable refrigerant is used.

Improper handling of the product could increase the risk of fire or explosion.

- Do not install the unit in a location where there may be flammable gas. If there is flammable gas around the unit, it can cause an explosion.
- Do not use mechanical devices or other means to accelerate the defrosting process.
- Make sure that ventilation openings in the product enclosure or built-in structure are free from obstruction to ensure proper operation and prevent potential hazards.
- Do not use mechanical devices to defrost the product.
- Do not store explosive substances near this product.
- Do not damage the refrigerant circuit.
- Do not puncture the refrigerant tubing.

1.2.4 Electrical Safety



WARNING

- Do not immerse the product or power cord in water or other liquids. Do not touch the power plug with wet hands.
- Do not pull the power plug out of the socket by pulling the power cord. Do not move, pull or carry the product by the power cord.
- Keep the product and power cord away from open flames and hot surfaces.
- When installing the power cord, avoid creating a tripping hazard. Do not kink the power cord or place it over sharp edges. Do not place the product where there is a

risk of it falling into any body of water.

- If an electrical appliance falls into water, do not reach for it. Immediately disconnect the power plug. Do not insert any objects into the housing.
- The unit must use a NEMA 5-15p electrical outlet for proper grounding.
- Please connect the power wire accurately according to the wiring diagram in the manual to avoid fire or burn out of the unit.
- Be sure to use correct materials during installation. Wrong parts or wrong materials may result in fire, electric shock, or premature failure.
- Licensed and bonded electricians are required for any and all electrical configurations outside of the scope of standard installation. If the power supply capacity is insufficient or the circuit is not completed, it may cause fire or electric shock.
- Don't unplug or plug in power during operation. It may cause fire or electric shock.
- Don't touch or operate the unit when your hands are wet. It may cause fire or electric shock.
- Don't place heaters or other electrical appliances near the power wire. It may cause fire or electric shock.

GFCI Power Supply Cord and Plug:

The product is provided with a GFCI (Ground Fault Circuit Interrupter) power cord and plug. It senses leakage of current, caused by a ground fault between or from the cord conductors and interrupts the circuit at a predetermined level of leakage current to protect against electric shock hazards.



The TEST and RESET buttons on the GFCI plug are used to check if the plug is functioning properly.

Operation:

Plug the power cord into a wall outlet.

Press the TEST button. The circuit should trip, cutting power to the product.³

Press the RESET button to restore power to the product.

If the TEST button is pressed and the product can still be turned on, current leakage has been detected.

Do not use the product or attempt to reset the GFCI plug.

WARNING

- DO NOT press the TEST button while the product is operating.
- The TEST and RESET buttons should not be used as "ON" and "OFF" switches.
- The cord and plug are not intended to offer protection to externally connected loads or supply circuits.
- The cord and plug are intended for indoor use or under light rain. We recommend covering it at all times.
- In case an extension cord is needed, use a 14 AWG cord with a single plug end, rather than a power strip with multiple outlets, to ensure stable and efficient operation.

1.2.5 Others

- Make sure that the unit is installed safely. If the unit is not secure or not installed properly, it may cause damage.
- If the unit is installed in a closed area or limited space, consider the size of the room and ventilation to prevent suffocation caused by refrigerant leakage.
- Install on the ground safely. Read the installation instructions. Improper installation may result in fire, electric shock, falling of the unit, or water leaking.
- The unit should be only removed and repaired by a professional technician.
- Improper movement or maintenance of the unit may cause water leakage, electric shock, or fire. Please find a professional technician to do it.
- It is recommended to keep it dry and avoid unnecessary splashing or spraying of water on the product. Do not immerse the product in water.
- In case of harsh external conditions (such as heavy rain, flood, extreme heat over 35°C (95°F) with direct sunlight), immediately unplug the product, and cover it or place it in a safe and dry environment.
- Never attempt to clean the product by immersing it in water and do not use a steam cleaner to clean it.

1.2.6 Health & Safety

- Cold and hot water immersion involves inherent health risks. Failure to follow all warnings and instructions may result in serious injury, loss of consciousness, or death.
- Always consult a qualified healthcare professional before using this product.
- Sudden or prolonged exposure to extreme water temperatures may place significant stress on the body. Hot and cold immersion can affect heart rate, blood pressure, circulation, and breathing.
- Prolonged exposure to hot water may cause hyperthermia, dehydration, dizziness, nausea, fainting, or heat exhaustion. Extended immersion in hot water may also place excessive stress on the heart and circulatory system.
- Do not use this product without physician approval if you have, or suspect you have, any of the following conditions:
 - Heart disease or other cardiovascular conditions
 - High or low blood pressure
 - Respiratory conditions (including asthma)
 - Circulatory disorders or peripheral vascular disease
 - Neurological conditions
 - Sensitivity to heat or cold
 - Are pregnant or may be pregnant

2 OVERVIEW OF THE UNIT

2.1 Parameters

Product Name	Chiller
Model No.	FDC-1A
Input Power Supply	110-120V~/ 60Hz
Input Power (Cooling)	0.69 kW
Input Power (Heating)	1.06 W
Compressor Power (Cooling)	0.560 kW
COP	4.08
Cooling Capacity	2.81 kW
Heating Capacity	3.38 kW
Working Ambient Temperature Range	33.8~109.4F (Cooling) 33.8~95F (Heating)
Refrigerant	R410a
Refrigerant Weight	550 g
Temperature	32.5~108F (Adjustable)
Disinfection	Ozone Generator
Circulating Pump	88w DC Motor
Filter	Installed External
Remote Control	IOS & Android APP, WIFI
Moving Wheels	YES
Carry Handle	YES
Quick Connector	YES
Net Weight	103lbs
Product Size	21.3" x 15.4" x 25"

2.2 APPEARANCE

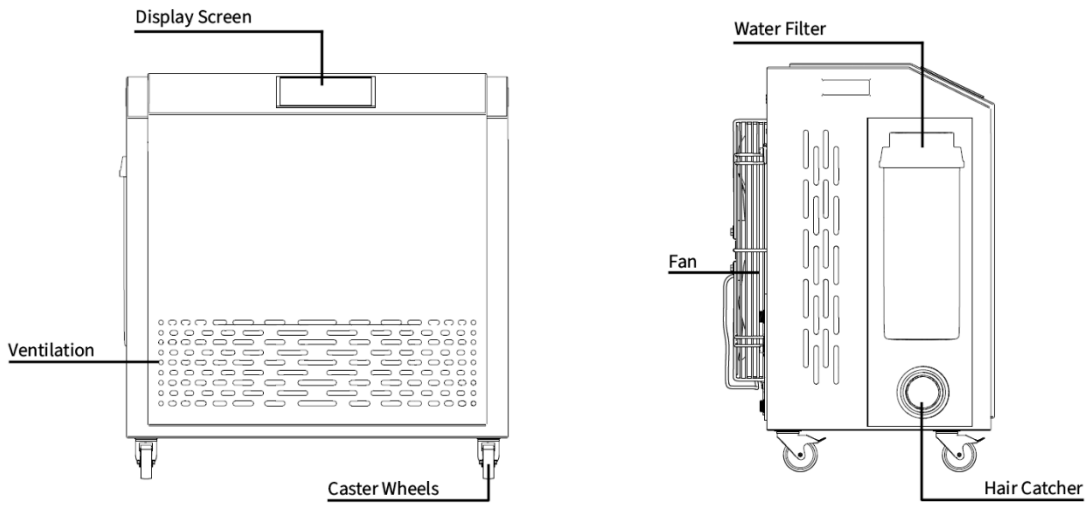

2.3 DIMENSIONS

Dimension Unit: (Inch)

Model	A	B	C	D	E	F	G
FDC-1A	21.3	15.4	25	21.2	17.4	5.5	3.8

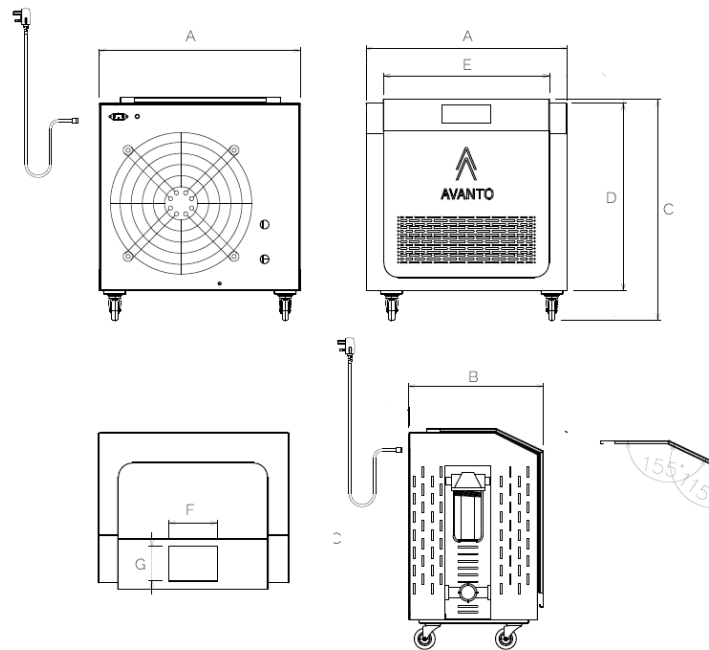



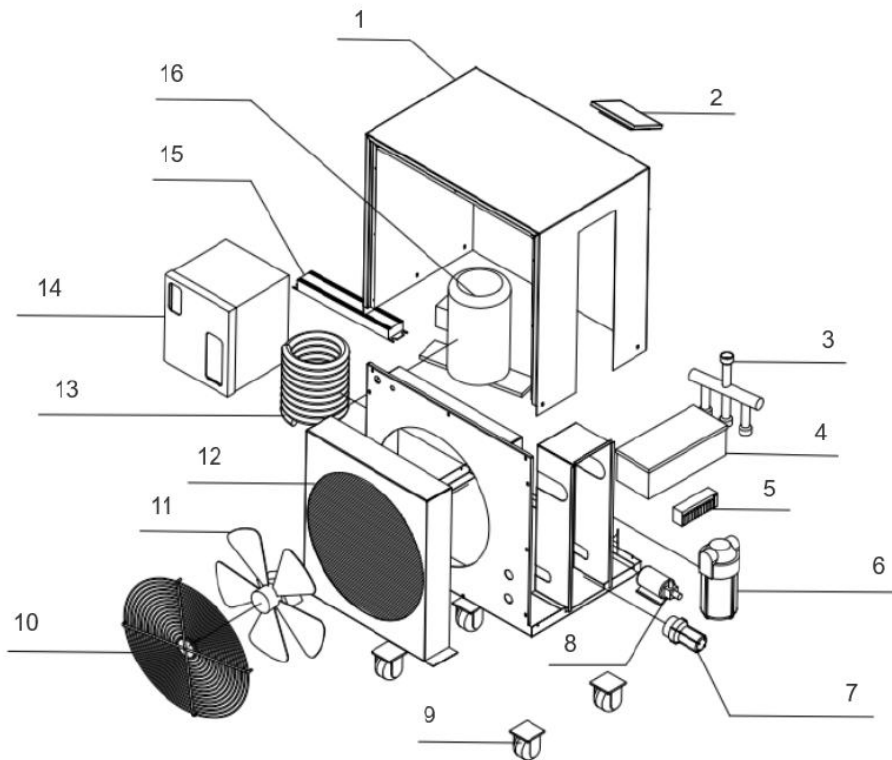



2.4 COMPONENTS



NO.	Material	NO.	Material
1	Case	9	Casters
2	Control Panel	10	Fan Shield
3	4-Way Valve	11	Fan Assembly
4	Electrical Board	12	Condenser
5	Ozone Generator	13	Heat-Exchanger
6	Main Filter	14	Exchanger Bubble Box
7	Hair Net Filter	15	Transformer
8	Water Pump	16	Compressor

2.5 INCLUDED ACCESSORIES

						
5" Filter Assembly	5" (5 Micron) Filter	Main Filter Wrench	Secondary Filter Wrench	LED Remote	Water Hose Lines	Secondary Filter Screen
1 Unit	2 Units	1 Unit	1 Unit	1 Unit	2 Units	1 Unit

3 INSTALLATION AND CONNECTION

3.1 Transportation

1. When storing or moving the product, the product should be in the upright position.

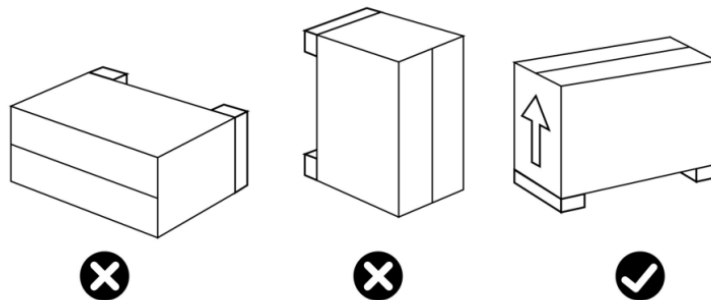

2. When moving the unit, do not lift the water union since the heat exchanger inside the unit will be damaged.

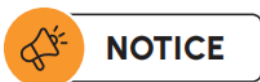
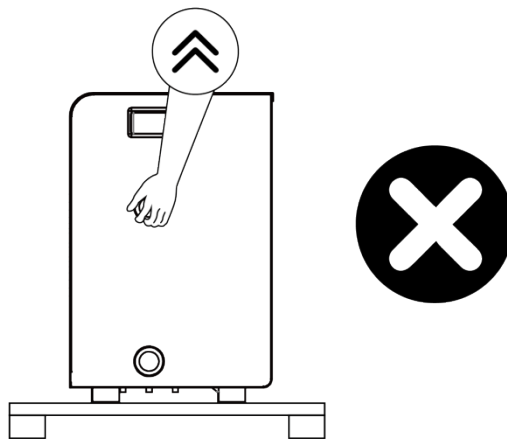

The product can be moved around with the castors and by pulling one of the handles. Once the product location is fixed, engage the brakes on the castors to prevent the product from moving further. **Wait for at least 24 hours before starting to use the product to allow the refrigerant within the product to settle properly. Do not move the product again during use.**

3.2 Installation Instruction

3.2.1 Location and Space



NOTICE

Improper product placement may result in poor heat dissipation and overheating. Overheating may damage the product and will not be covered under warranty.

Please observe the following rules regarding selecting product locations.

- Do not put anything more than 60 inches in front of the fan system.
- Please leave 20 inches of space on the sides and front of the chiller product.
- Place the product on an easily accessible, level, dry, heat resistant and sufficiently stable surface. Do not place the product on the edge of the surface.
- The product requires adequate air flow to cool the water, avoid using enclosed spaces such as small cabinets or closets unless they are specially modified for ventilation.
- Keep the unit as much as possible out of the reach of children.

① Installation Space

Unit: Inch

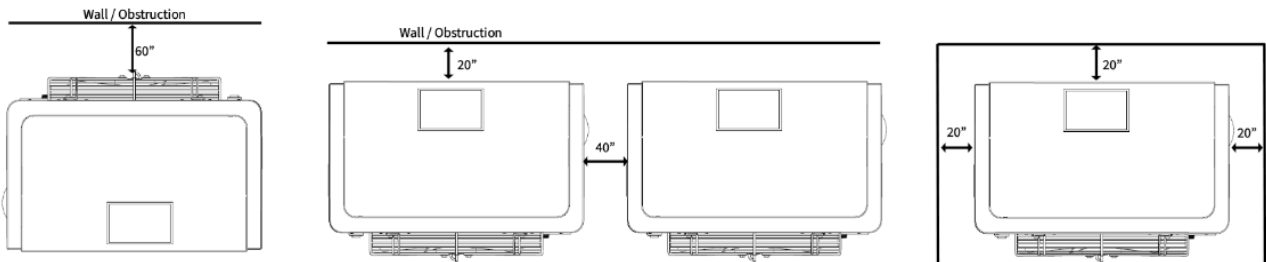

② Installation Height Difference

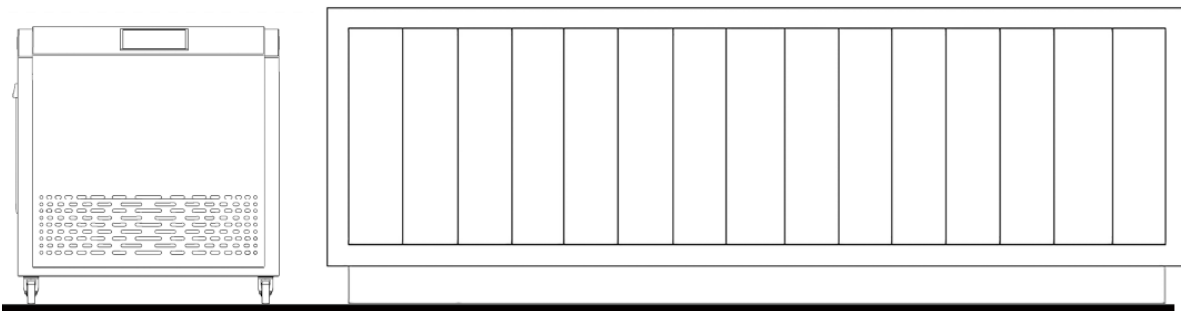

Equipment Configuration: Ensure that the chiller is installed at the same level as the bathtub, with the bathtub being allowed to be slightly higher.

Additionally, the water level in the bathtub must be above the chiller's water inlet to avoid issues with the pump's ability to draw water due to height differences.

Water Flow Efficiency: A level installation helps optimize the water flow path, enhancing the effectiveness of the cooling cycle.

Operational Safety: Proper height configuration reduces the risk of malfunction, ensuring safe and stable operation.

③ About Shielding Measure

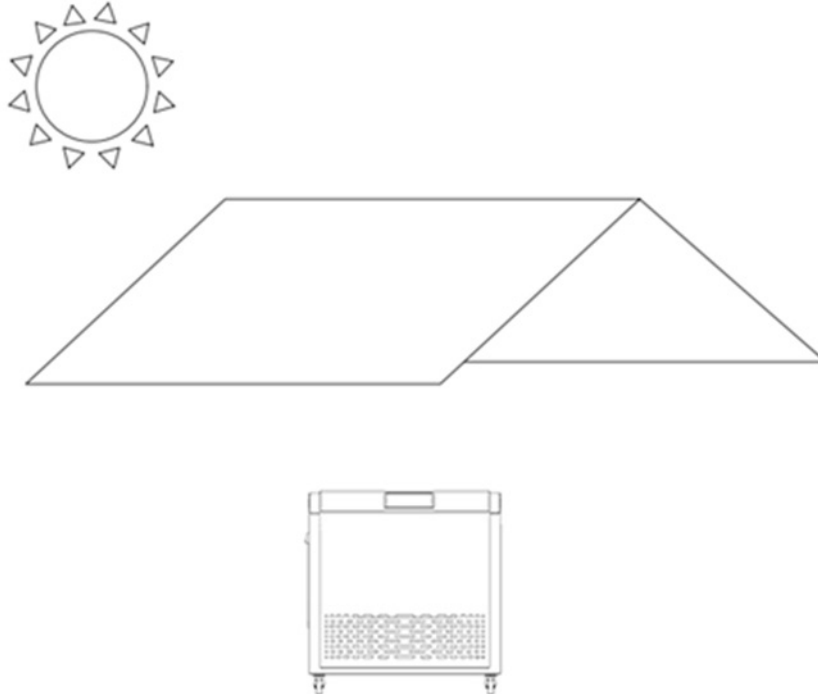

Avoid Direct Sunlight: The LCD touchscreen should be placed in a shaded area to prevent prolonged exposure to sunlight, which can cause overheating and failure.

Tent Protection: When using outdoors, please use a tent or shading device to effectively protect the touchscreen from sunlight and rain.

Waterproof Measures: Ensure the touchscreen is kept away from rain and damp environments to prevent water from entering and causing damage.

Cleaning Instructions: Use a clean, soft cloth to clean the screen, avoiding corrosive or abrasive cleaners to prevent scratches on the surface.

Disclaimer:

Please note that if the LCD touchscreen is damaged due to failure to follow the above usage instructions, Finmark Designs will not be liable for warranty costs.

3.2.2 Installation Layout

The following figure shows a simplified schematic diagram of the water system connection. The parts in the dotted box are all internal parts of the chiller

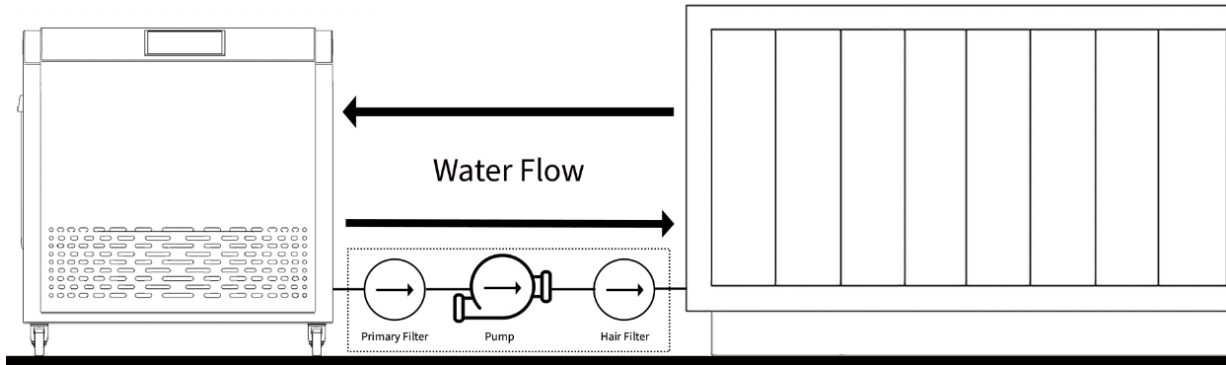

No.	Item	Quantity
1	Chiller	1

3.2.3 Leveling

Allow the chiller to stand upright on a level surface for 20 minutes before starting. The fluid in the compressor needs to settle. Failure to do so could result in irrevocable damage not covered under warranty. Ensure the chiller is always upright and never turned over.

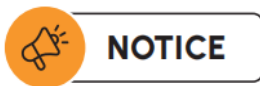
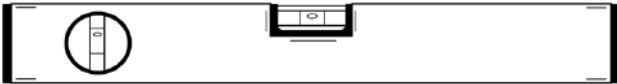

NOTICE

Condensed water may flow out from the drain outlet during operation. If necessary, place a container under the drain outlet to prevent spillage.

3.2.4 Electrical Installation

To function safely and maintain the integrity of your electrical system, the unit must be connected to a code compliant power outlet.

① The product must be connected to a code compliant circuit installed by a licensed electrician and follow all local and federal electrical codes.

Model	Power Supply Wires		
	Electricity Supply	AMPS	Wire Requirements
FDC-1A	110-120V~/ 60Hz	15a	AWG14

3.3 Assembly



INFO

Keep the chiller upright and unplugged for at least 24 hours before use. This allows the refrigerant within the product to settle properly. This precaution is necessary due to shaking and shocks during transit.

3.3.1 CONNECTING WATER LINES

IMPORTANT: Connect the “INLET” on your chiller to the “OUT” on your plunge bath with the supplied quick connect hose. Connect the “OUTLET” on your chiller to the “IN” on your plunge bath with supplied quick connect hose. Hand tighten only. Once the hoses are attached you may fill your cold plunge.



WARNING

Once the hose lines are connected to the tub, verify that both the In and Out line valves are in the open position.

Operating the chiller with either valve closed will restrict water flow, which will damage the pump and result in unit failure.

Any damage caused by running the chiller with closed valves is not covered under warranty.

3.3.2 INSPECT WATER FILTERS

Inspect pre-installed mesh filter and main filter for any debris. Hand check both filter cartridges to ensure each are tight.

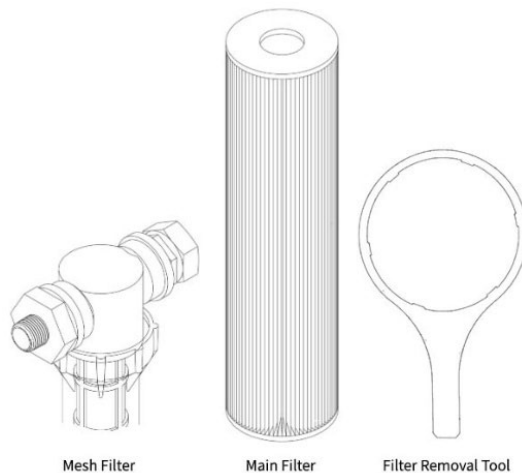

4 TRIAL AFTER INSTALLATION



Please check all the wiring carefully before turning on the chiller.

4.1 Inspection Before Trial Running

Before running test, confirm below items and write \checkmark in block;

<input type="checkbox"/>	Correct installation
<input type="checkbox"/>	Power supply voltage is the same as unit rated voltage
<input type="checkbox"/>	Correct piping and wiring
<input type="checkbox"/>	Air inlet & outlet port of unit is unblocked
<input type="checkbox"/>	Drainage and venting is unblocked and no water leaking
<input type="checkbox"/>	Leakage protector is working
<input type="checkbox"/>	Piping insulation is working
<input type="checkbox"/>	Ground wire is connected correctly
<input type="checkbox"/>	Check whether the filter is tightened
<input type="checkbox"/>	Whether the sealing ring in the water filter is installed properly
<input type="checkbox"/>	All valves are in the open position

4.2 Trial Running

The test run can begin after completing all installation.

Step 1: All wiring and piping should be connected well and carefully checked, and fill water tank before turning on the power switch.

Step 2: Wait until the water filter is filled and there are no other air leaks, press “on-off” button on control panel to run the unit at setting temperature.

Step 3: Functionality Checklist:

- ① Is the chiller turning on?
- ② Is the chiller making any abnormal noise?
- ③ Is the control panel turning on?
- ④ Are there any leaks at any connection points or at any location on the chiller?
- ⑤ Is the condensation drain dripping water?
- ⑥ Is the chiller’s power cable hot to the touch?

5 CONTROLLER OPERATION

5.1 Control Panel Diagram

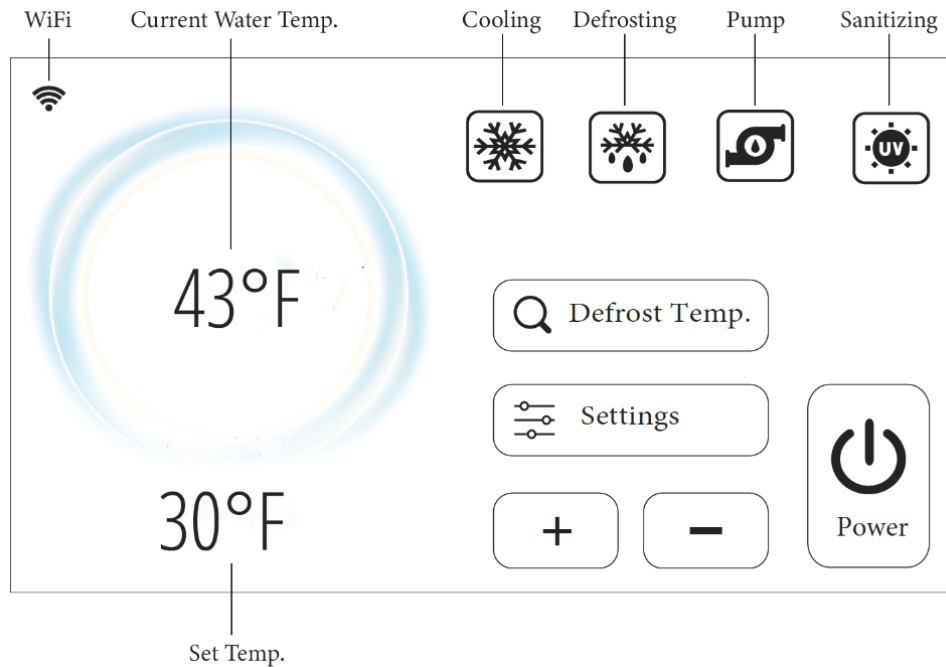

5.1.1 Power On Interface

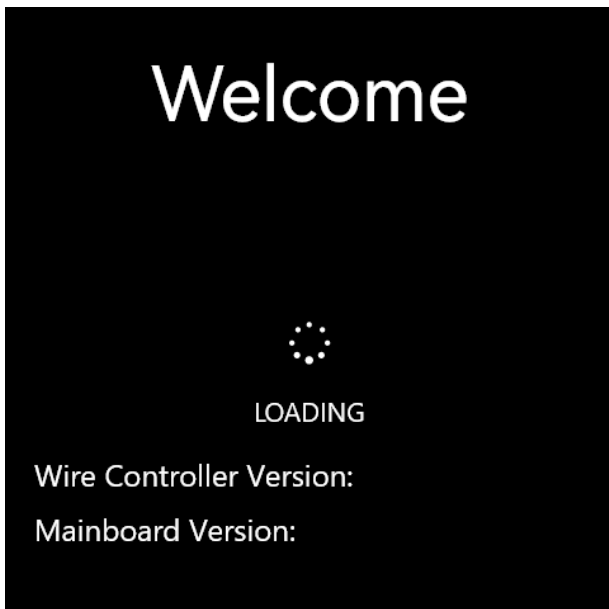

Power on the screen to enter the controller options.

5.1.2 Main Interface

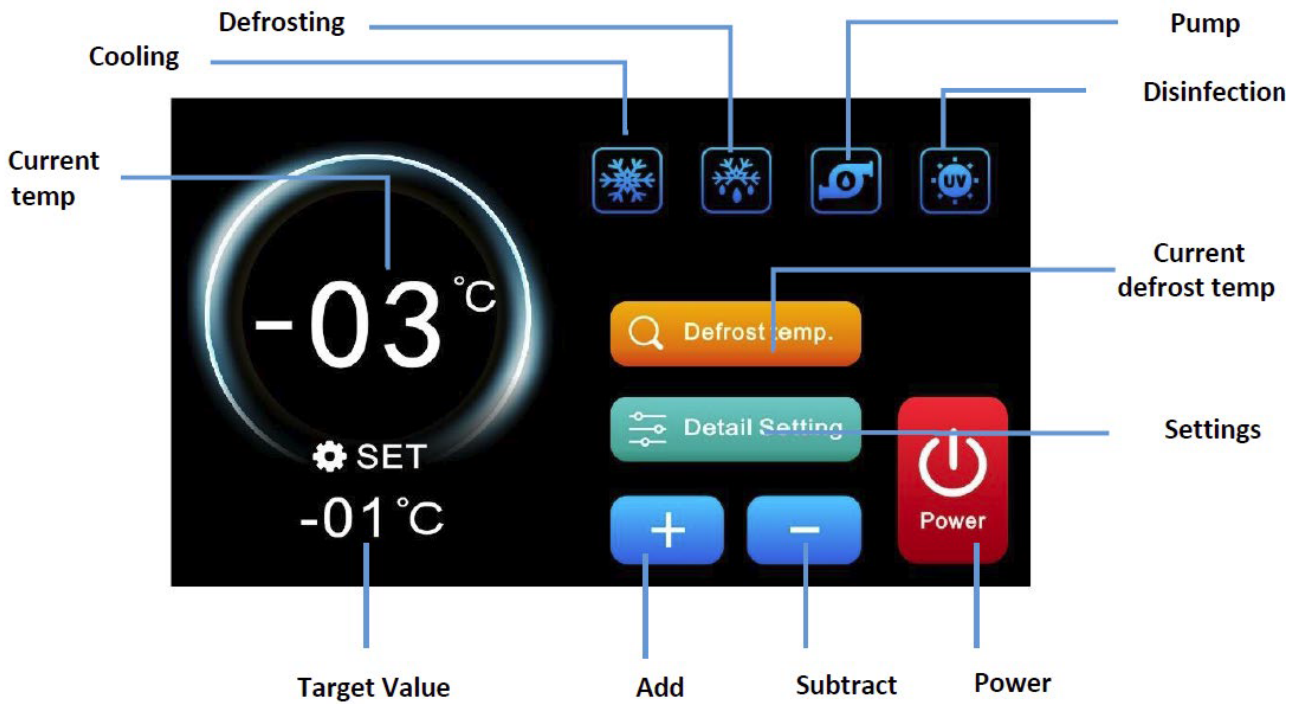





****Status icons appear when function is running****

5.1.3 Symbols and indication instruction







Icon	Indication	Meaning	Icon	Indication	Meaning
	Network status	Solid indicates connection		Fault icon	Fault
	Network status	Blinking indicates searching for network		Disinfection icon	Ozone Disinfection activated
	Pump fault	Pump Failure		Melting Snowflake	Defrost activated

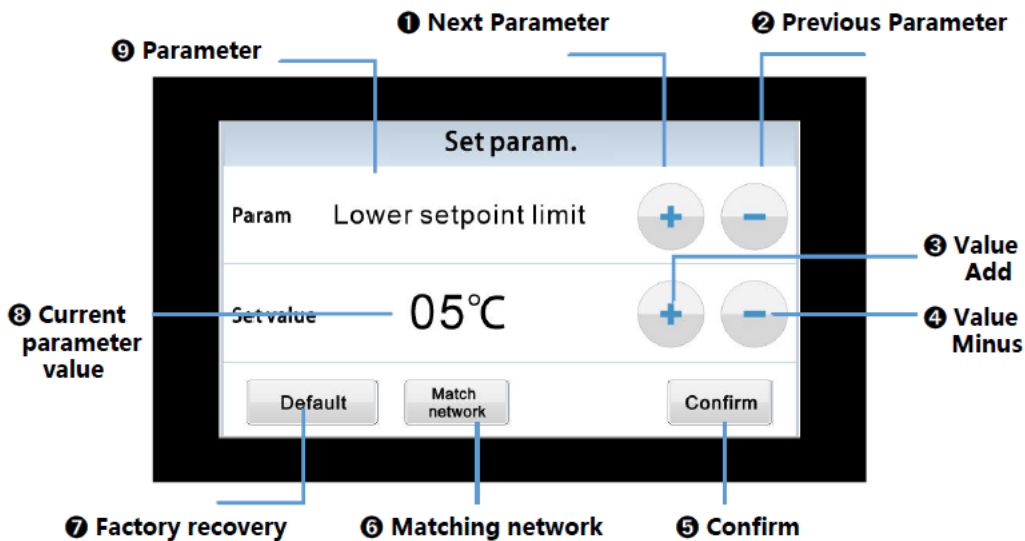



5.2 Key Operating Instruction

Only the icon lights up to indicate that the device's current functions are running

- ① Hold  3s to turn off the device and hold down for 1s to turn on the device
- ② Press  or ③ Press  to adjust the temperature
- ⑦ Press  to start heating/cooling
- ⑪ Press  to check the current defrost temperature



- ① Press  or ② Press  jump to next or previous parameter
- ③ Press  or ④ Press  to adjust parameter value
- ⑤ Press  to confirm parameter value or back to main interface
- ⑥ Hold  for 3s to matching network
- ⑦ Hold  for 3s to factory data reset

Item		Operation
ON & OFF		Click "  ' power button to turn the main interface on or to shut down.
Set the Water Temperature		Set the target temperature value through the "+" and "-" keys on the main interface.
Fault Display		When there is a fault, the fault icon  on the LCD screen will light up. Click the fault icon "  " to view the reason for the current fault. You will see a fault code and a fault name.
Screensaver / Screen Out		In all interfaces, if the screen is not touched for 60 seconds, the screen will automatically dim to 20% power. When the remaining time is less than 5 minutes, the screen check time is equal to the rest time, 1 minute; Otherwise, the extinguishing time is equal to 4 minutes. In the dormant state, click the screen wire controller to display the screen saver interface. In the state of 20% brightness: click the screen to increase the brightness to 100%.
Lock	Manual Lock Screen	Press the "  " lock key on the main interface, in order for wire controller to the lock screen.
	Automatic Lock Screen	Lock the screen time, and the wire controller performs the lock screen action.

Item		Operation
Query	Status Query Function	<p>Step: Click the setting key "Swipe to page 4" in the main interface status parameter (password: 168).</p> <p>Enter the password to read parameter interface (the line controller reads all the master control advanced parameters). Return to the previous page and pop-up prompt "Input password error" will appear. After the wire controller reads all the advanced parameters, jump to the "Run State" interface. If 10S reads all the advanced parameters, return to the previous page.</p>
Query	History Fault Query	<p>Step: Click the setting button "Historical fault button" in the main interface to enter the password (password: 589).</p> <p>Historical fault can record a total of 18 sets of records. Displayed and recorded in reverse order, the latest fault is always displayed in the front row, and the historical fault has the function of power loss memory.</p>
	Version Query	<p>Enter the step: Click the setting button "Swipe to page 4" " Software version:</p> <p>(Master control version, wire controller hardware version, wire controller software version)</p>
System Setting	Basic Settings	<p>Click the setting button in the main interface and swipe to the third page. The contents of the interface are: "Call to start", "Button sound", and "Temperature scale switch".</p> <p>When the key sound is set to open, the sliding button interface buzzer will not ring; Click the screen button buzzer to ring. When the key sound is set to close, the screen operation buzzer does not ring.</p>

	Advanced Parameters	<p>Step: Click the setting key "Advanced parameter key" in the main interface to enter the password interface (password: 589).</p> <p>Enter the correct password to enter the reading parameter interface (the line controller reads all the advanced parameters of the main control). Return to the previous page and pop-up prompt "Input password error".</p> <p>The linear controller reads all the advanced parameters and jumps to the advanced parameters interface. If 10S reads all the advanced parameters, return to the previous page.</p>
Para. Setting	Restore Factory Settings	<p>Step: Click the setting button "Swipe to page 4" and "Restore Factory Settings" to enter the password interface (password: 400866).</p> <p>Enter the correct password, you will enter the recovery factory settings interface. At this time, the line controller issues the recovery factory settings instruction with 06 and reads all advanced parameters again. Return to the previous page and pop up to prompt "Enter the password error".</p> <p>The wire controller reads all the advanced parameters or returns to the main interface beyond 10S.</p>
Time	Time setting	<p>Enter the step: in the main interface, click the setting button "Swipe to page 4", set the time.</p>

5.3 Wi-Fi Settings

5.3.1 Wi-Fi Module Configuration Steps:

1. Network Setup
 - a) Step 1: Download the "Smart Life" app and sign up for your account.
 - b) Step 2: Turn the Bluetooth function on and license the app for Bluetooth rights.
 - c) Step 3: Open the mobile APP, click the + number in the upper right corner, click the scan code button in the upper right corner.
 - d) Step 4: Click the setting key in the main interface-> Click the Wi-Fi button-> swipe to the second page-> Click the distribution network button-> Yes
(the wire controller enters the distribution network mode)

2. The distribution failure factors are as follows:
 - a) Please confirm that your router is not a wireless router provided by telecom carrier (this type of wireless router has poor compatibility due to the functions of some telecom operators and cannot add our equipment). Please use wireless routers such as Asus, Netgear, TP-LinK and other brands.
 - b) Wi-Fi needs to turn on the broadcast, must *not* be set to be hidden, and make sure that the phone is using the 2.4G Wi-Fi frequency band. Add equipment (check whether the 2.4G band and 5G band are one Wi-Fi account, if it is recommended to change to different account and change to 2.4G band network in the distribution network).
 - c) Please confirm that the network environment signal of the equipment is strong and stable. Investigation method: download the network speed measurement App (ensure that the mobile phone is connected to 2.4 Ghz network), put your mobile phone in the same position as the device, and then test the network upload and download speed of the location (ensure that the speed is at least 2 MB/s, download 2 MB/s or upload 16 Mbps, download 16 Mbps).
 - d) If the network is normal, but the equipment distribution network fails, please confirm that the router is overloaded. You can try to close a devices Wi-Fi feature empty channel reconfiguration.
 - e) If the router opens the wireless MAC address filtering, you can try to move the device out of the MAC filter list of the router to ensure that the router does not prohibit the device from networking or close the MAC address filtering.
 - f) Detect whether the phone is enabled and whether the Bluetooth function is authorized to the app.

5.3.2 Software Installation

- ① Method 1: Search "Smart Life" in your APP store, install "". Click "GET" to install.

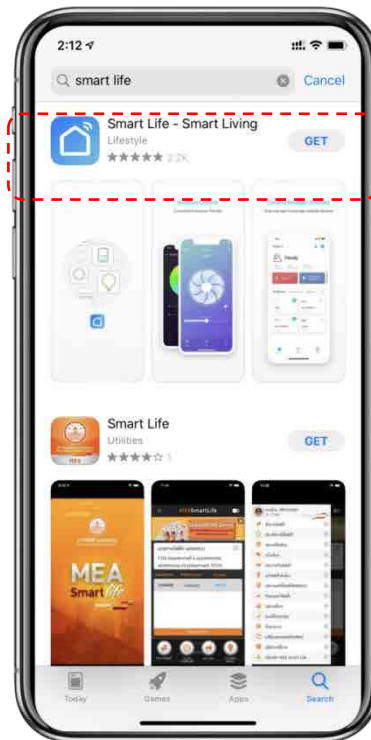

- ② Method 2: Scan the QR code below.



For IOS/Android Users

5.3.3 Software Startup

After installation, click "" on your desktop to start up Smart Life.



5.3.4 Software Registration and Configuration

1. Registration

① Users that don't have account can click "Register" to create an account:

Register → Enter Your Phone Number → Get Verification Code → Enter Verification Code → Set Code

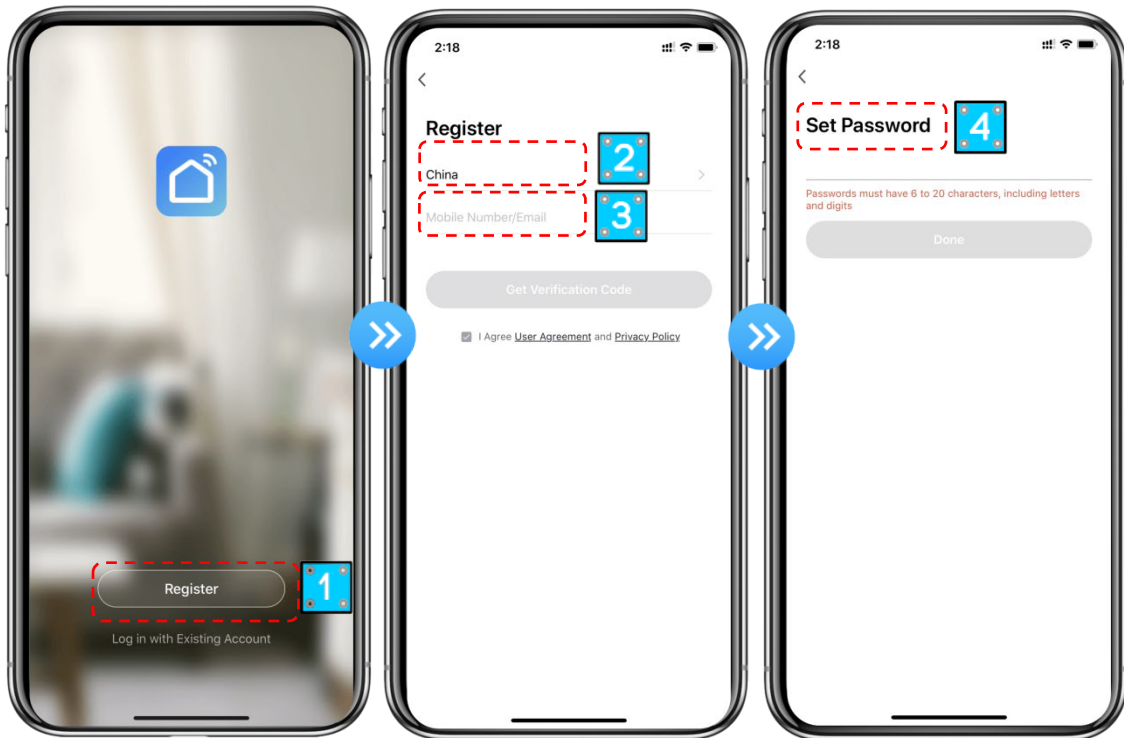

② After registration, you need to Create a Home:

Create a Home → Set Home Name → Set Home Location → Add Rooms

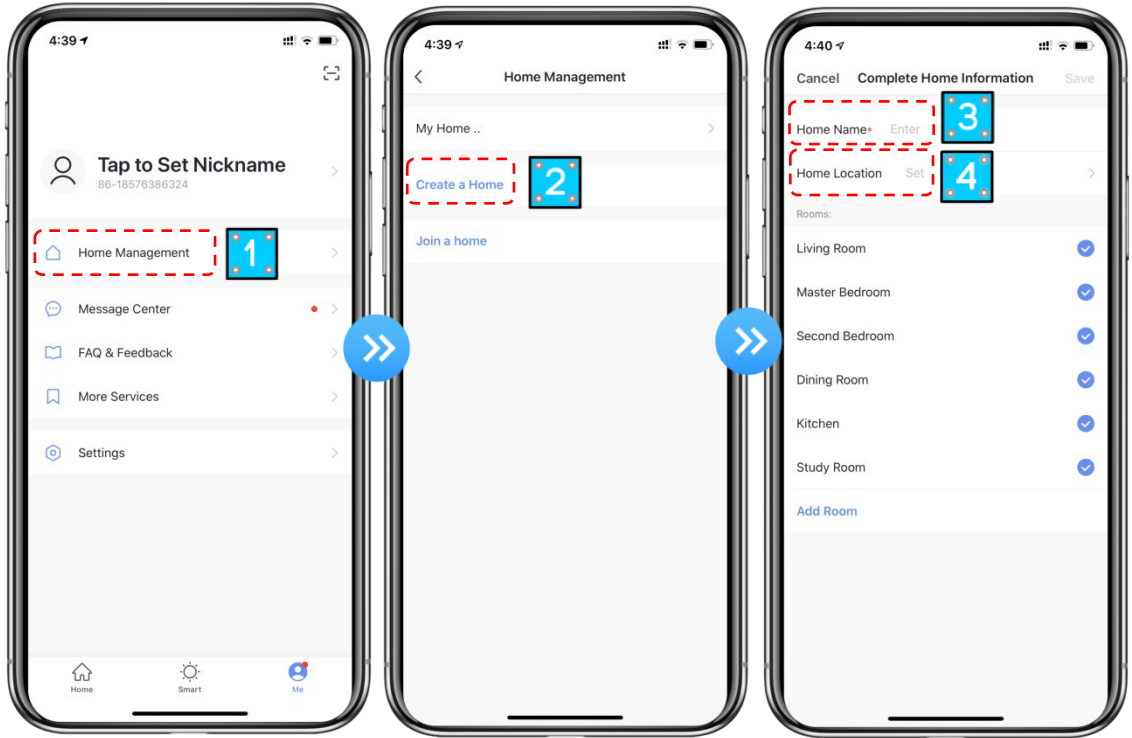

2. Account ID + Password Login

- ① Existing accounts can be logged in directly, in the following order:

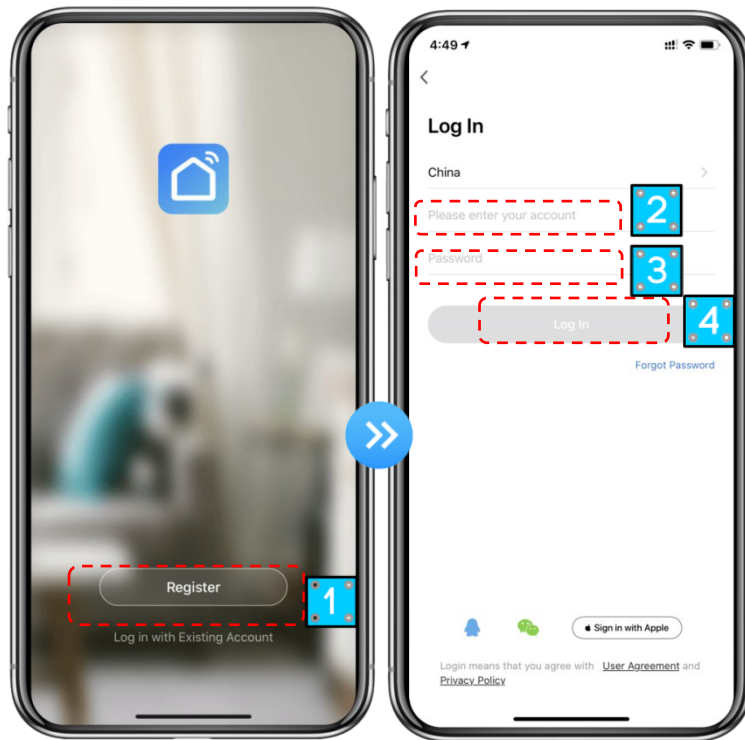

- ② If you forget your password, you can choose “Forgot Password” and login with your verification code. Enter your phone number → Get verification code.

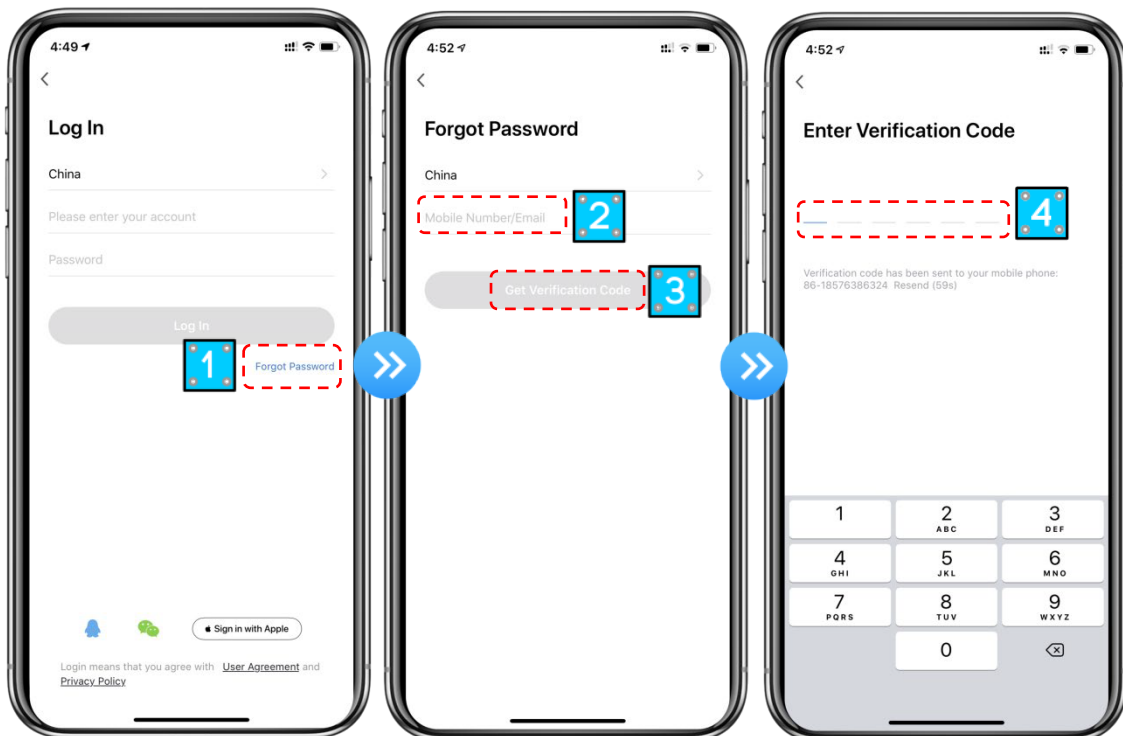

- ③ After creating a home or have logged in, enter the main interface of APP.

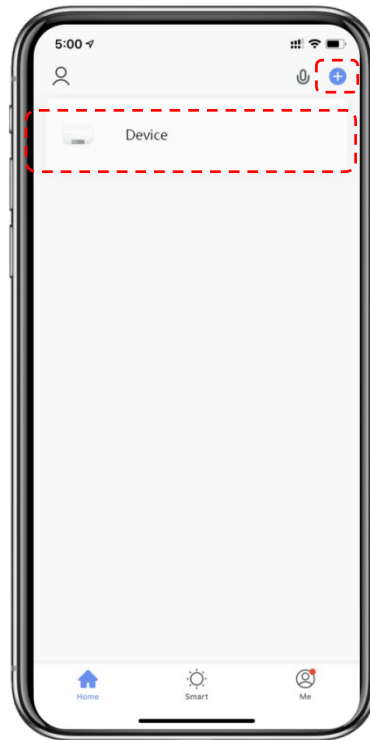

Note:

Click the device to check the status, and you can set the operating mode, ON/OFF, timer. Click “+” to add devices.

5.3.5 Software Function Operation

- After the device is bound successfully, enter the operation interface of “Chiller” (Device name; modifiable)
- In the main interface of “Smart Life”, click “Chiller” to enter the operation interface.
-

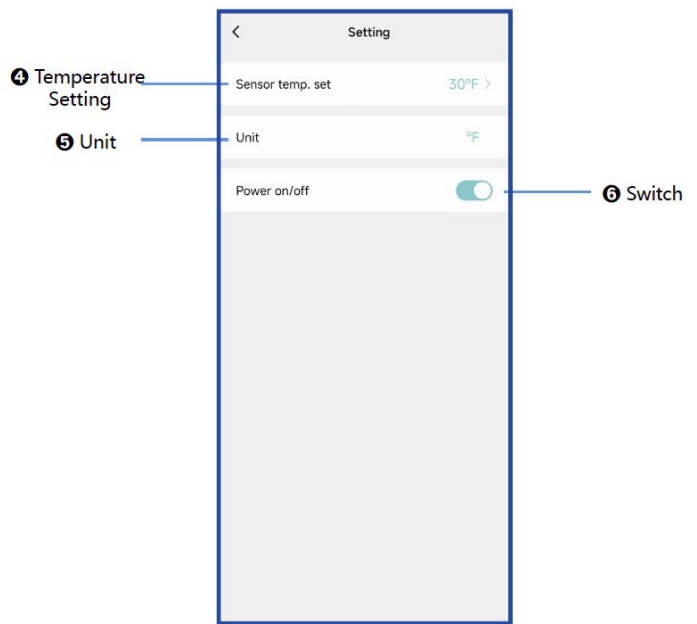
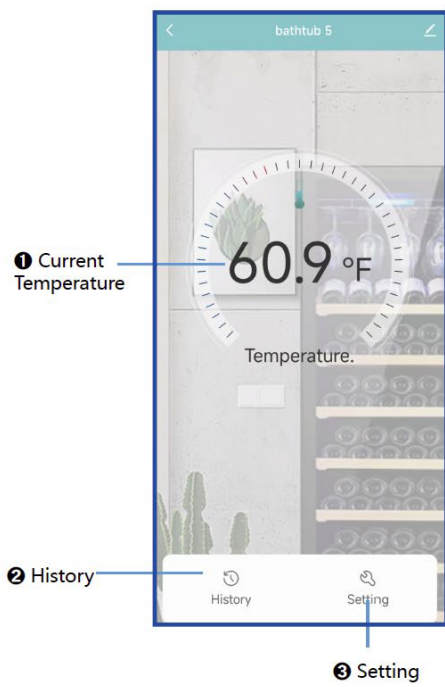

6 TROUBLESHOOTING

Code	Fault Description	Solutions
E01	Wire controller communication failure	<ol style="list-style-type: none"> 1. Reconnect the wire controller cable. 2. Replace the wire controller. 3. Replace the main board. 4. Communication wire is placed separately from the strong electricity wire.
E11	Temperature outlet probe failure	<ol style="list-style-type: none"> 1. Reconnect the cable. 2. Replace the probe. 3. Replace the main board.
E14	Environmental temperature failure	
E16	Exhaust temperature failure	
E21	EEPROM check error	Shutdown and restart
E25	Low water temperature shutdown protection	<ol style="list-style-type: none"> 1. The outlet temperature is set within the rated range. 2. Replace the outlet water sensor if necessary. 3. Replace the motherboard if necessary. 4. Open the valve of water system. 5. Clear blockage in heat exchanger or filter valve. 6. Replace suitable water pump.
E31	High pressure switch	<ol style="list-style-type: none"> 1. Reconnect the cable. 2. Replace the high/low pressure switch. 3. Replace the main board.
E32	Low pressure switch	
E44	Return temperature probe failure	<ol style="list-style-type: none"> 1. Reconnect the cable. 2. Replace the probe. 3. Replace the main board.
E55	Inhale temperature failure	
E58	Fin temperature failure	
E65	The number of parameters is super bound	Restore factory setting.
E68	Air conditioning water flow is insufficient	<ol style="list-style-type: none"> 1. Check if the pump is running properly / clean or replace the blocked part. 2. Replace suitable water pump. 3. Need to change the water pipe. 4. Reset the water flow switch manually.
E71	Temperature failure after valve	<ol style="list-style-type: none"> 1. Reconnect the cable. 2. Replace the probe. 3. Replace the main board.
E78	EEPROM hyper bound of parameter values	Restore factory setting.

8 MAINTENANCE



NOTICE

Improper handling of the product may result in damage to the product. Before undertaking maintenance work on the unit, ensure that you have disconnected the electrical power supply.

8.1 Cleaning

- a. Use a damp cloth to clean the surface after the machine is unplugged and cooled. Do not use detergents or other corrosive cleaning products as they may damage the surface.
- b. Make sure that no water or other liquids penetrate the casing, and do not immerse the product in water or other liquids.

8.2 Maintenance

- Check filters every 10 uses, including cartridge filters and hairnet filters.

If filters are dirty or clogged:

Main Circulation Filter:

- ① Remove the side panel and replace the filter.
- ② If necessary, use a wrench to aid removal and subsequent installation.
- ③ The filter must be aligned during installation.

Secondary Hairnet Filter:

- ① Place a container under the hairnet filter.
- ② Remove the hairnet filter, empty it, clean it and reinstall it.

Replacement Filter:

To order replacement filters contact your dealer.

Part Number - **620-130064**

Hose and Internal Components:

Use spa cleanser once every 6 months. Never use the bath with the spa cleanser in the water.

Procedure:

Put the spa cleanser inside the bath water and let the chiller run for 2 hours. Once this is done, empty the bath completely and then fill it up again with water.

Fan Maintenance:

Use compressed air to blow out debris and dust from the fan components. To maintain optimal performance, this procedure should be completed every 6 months. Failure to remove debris and dust every 6 months can result in premature failure and denial of warranty claims.

Storage:

You must remove any stagnant water from the chiller prior to storage beyond 1 month. To remove all water from the machine, remove the hoses and the filter cap. Tilt the chiller to the side to properly drain all water.

8 WARRANTY

Limited Warranty

This Limited Warranty is in addition to, and does not override, your statutory rights that cannot be waved or limited by contract. Consumers are free to make a warranty claim under this Warranty. They may also exercise their statutory consumer rights.

Note: This Limited Warranty is valid only for products that you bought through a certified dealer. (the "Products").

Finnmark Designs ("we, us and our") extend the following limited warranty to the buyer of the Products ("you and your"):

- The Product you bought will match the descriptions we gave you when you contacted us.
- The quality of the Product will be reasonably satisfactory.
- The pumps, heater, and control system are warranted against malfunctions due to defects in workmanship or materials.
- The chiller's plumbing components are warranted against leaks due to defects in workmanship or materials.

Your warranty will be valid for the following duration: one year from the date of purchase. For backorders, your warranty will start on the day you receive your Finnmark Designs Chiller. The date of purchase on your electronic receipt will be used to calculate warranty periods. Finnmark Designs will replace or repair all defective Products by sending replacement parts for product repairs. In the unlikely event the water chiller is not fixable, we will reimburse you the purchase price that you paid, less a prorated amount based on time of use.

What our limited warranty does not cover:

Finnmark Designs warranty commitments do not cover claims resulting from:

- Wear and tear, or due to aging/use of materials; aesthetic defects or minor deviations of the chillers advertised through our partners or any naturally occurring variations in the materials used or manual assembly of Products;
- Improper assembly, use or care, contact with animals, or site or environmental conditions (such as environments with high heat, high humidity, high salinity or pollutant gases);
- Use in anything other than a domestic, private and non-commercial settings;
- contact with moisture (including, without limitation, due to conditions such as hyperhidrosis or contact with aqueous or organic solvents), thermal degradation or elements that are known to cause a breakdown of materials;
- Modifications or failure to follow the recommended assembly or aftercare instructions; abuse, negligence, accident, fire or water damage, transportation by the customer or other causes beyond our control.
- Failure to purchase and or replace required hard water filters if in zone Hard and Very hard water locations.

How to make a warranty claim

Please submit your warranty service claims promptly. For your warranty claims to be effective, you must submit your claims within 14 days of defect.

You must provide your order number for warranty validation. You must provide clear images of the alleged defect. Without clear images, Finnmark Designs will be unable to process your claim.

For all defects in manufacturing, we will ship the replacement parts at no charge. Any and all labor costs are not covered under this warranty. All defective parts shall be returned to Finnmark Designs at your cost for the evaluation of warranty claims.

Limitation on transferability of warranties

The Finnmark Designs Warranty applies to the original purchaser. Warranties are non-transferable.

Water chiller limited warranty information:

1 YEAR EQUIPMENT AND CONTROLS: Pumps, heater, and control system – are warranted against malfunctions due to defects in workmanship or materials for one year from the original date of purchase.

1 YEAR PLUMBING COMPONENTS - The chiller's plumbing components are warranted against leaks due to defects in workmanship or materials for one year from the original date of purchase.

The factory installed filter & pump is warranted against malfunction due to defects in workmanship or materials for one year from the original date of purchase, except the paper core filter itself which should be replaced every 30 days.

This Limited Warranty is void if Finnmark Designs or its designated representatives determines that the chiller or ice bath connected has been subjected to damage or failure due to installation of aftermarket parts that are not Genuine Finnmark Designs branded Parts & Accessories. This disclaimer includes, but is not limited to filters, pumps, valves, repair parts and other accessories. Finnmark Designs brand Parts & Accessories are built to our highest standards of quality, durability and performance, and they are designed to work with your chiller to ensure optimal performance and function.

PERFORMANCE & TEMPERATURE

To file a warranty claim, contact Finnmark Designs or the approved dealer whom the water chiller was purchased from.

The temperature the Finnmark Designs chiller can have a variation in advertised temperature of +/- 5°F. Factors that contribute to variations are extreme heat climates, sun exposure, low amp rating to chiller, improper electrical outlet, unchanged or clogged filter, cold plunge water volume.

WARRANTY LIMITATIONS

This Limited Warranty is void if: Used in a commercial setting, the Manufacturer or its designated representative determines that the chiller and ice bath connected has been subjected to alteration, neglect, misuse or abuse, or freight damage caused by the common carrier; any repairs have been attempted by anyone other than a designated representative; or if the failure is caused by accident, acts of God or other causes beyond the control of the Manufacturer. Neglect, misuse and abuse include any installation, operation or

maintenance of the chiller other than in accordance with the instructions contained in the owner's manual provided with the chiller, including but not limited to the failure to maintain proper water chemistry and chemical balance and the use of abrasive or improper cleaners or non-genuine parts and accessories. Chiller's used in commercial applications are excluded from any coverage. The chiller owner accepts liability for repair work performed by anyone other than the Manufacturer or a designated representative. Finnmark Designs is not responsible for work performed on any units outside of the contiguous United States.

The limited warranty is void if proper maintenance as per the instructions are not kept. This includes filter changes, poor water chemistry and maintenance, or other forms of neglect. The chiller's warranty is ultimately voided if left with stagnant water inside for 6+ months without turning the chiller on for proper circulation.

The limited warranty is void if damage is caused by freezing conditions. The chiller should be moved to an inside location or in a properly insulated area during freezing conditions.

LIMITATIONS ON IMPLIED WARRANTIES

This Limited Warranty takes the place of all other warranties, express or implied, in fact or at law. All warranty service must be performed by the Manufacturer or its designated representative using authorized Finnmark Designs parts. No agent, dealer, distributor, service company or other party is authorized to change, modify or extend the terms of this limited warranty in any manner whatsoever. The Manufacturer will not be responsible for any statements or representations made in any form that go beyond, are broader than, or are inconsistent with any authorized literature or specifications furnished by Finnmark Designs. The Limited warranty does not cover the following; rust on the outer chiller casing or components as this can be caused by humid climates or exposure to severe weather conditions.

DISCLAIMERS

The MANUFACTURER AND ITS REPRESENTATIVES WILL NOT BE RESPONSIBLE FOR INCIDENTAL OR CONSEQUENTIAL DAMAGES, and shall not be liable for any injury, loss, cost or other damage, whether incidental or consequential, arising out of any defect covered by this limited warranty, including without limitation, loss of use of the chiller and cost for removal of defective product even if the Manufacturer was advised of the possibility of damage, and water damage. The liability of the Manufacturer under this limited warranty, if any, shall not exceed the original amount paid for the defective product. Coverage under this limited warranty shall commence as of the original date of purchase and the duration of such coverage shall not extend for any reason whatsoever beyond the stated time periods. These disclaimers shall be equally applicable to any service provided by the Manufacturer and its designated representatives.

LEGAL RIGHTS

This Limited Warranty gives you specific legal rights. There are no warranties applicable to Finnmark Designs products except as expressly stated herein or as implied by applicable state and federal laws. You may also have other rights that vary from state to state. Some states do not allow limitations on how long an implied warranty lasts, disclaimer of certain warranties, or the exclusion or limitation of incidental or consequential damages so some of the above limitations.

Technical Support
(224) 253-5909